



# SOLAR PANEL ENERGY (PTY) LTD

inquiry@solarpanelenergy.co.za

www.solarpanelenergy.co.za

## 12V 250AH GEL-VRLA BATTERY

### SP SERIES/ 6-CNFJ-250 12V250Ah

#### Applications

UPS and solar power systems  
 Firefighting equipment standby power supply  
 Medical treatment equipment, Alarm system  
 Telecommunication system, Railway station  
 Ship Equipment, Military Equipment  
 Control systems, Emergency lamp

### CONSTANT POWER DISCHARGE TABLES

Cut-off Voltage (V)	Minutes				
	5	10	15	20	30
1.6	1135.6	819.4	622.2	513.4	370.6
1.65	1077.8	792.2	605.2	503.2	367.2
1.7	1003	754.8	584.8	486.2	360.4
1.75	872.1	632.4	479.4	426.7	336.6
1.8	770.1	554.2	474.3	414.8	331.5
1.85	700.4	561	476	404.6	324.7

Cut-off Voltage (V)	Hours						
	1	2	3	5	6	8	10
1.6	221.34	128.18	93.5	61.54	55.44	43.92	37.08
1.65	217.94	127.5	93.16	61.54	55.44	43.56	36.72
1.7	216.24	126.48	92.48	61.2	55.08	43.56	36.72
1.75	205.7	119	92.65	60.86	55.44	43.2	36.72
1.8	202.3	117.3	91.46	60.35	54.36	42.66	36.54
1.85	198.9	115.6	90.44	59.84	53.46	42.3	36.18

### SPECIFICATIONS

Model	Nominal Voltage (V)	Capacity (Ah)	Dimensions (±3mm)			
			Length	Width	Height	Total Height
6-CNF-200	12	200	521	241	220	220

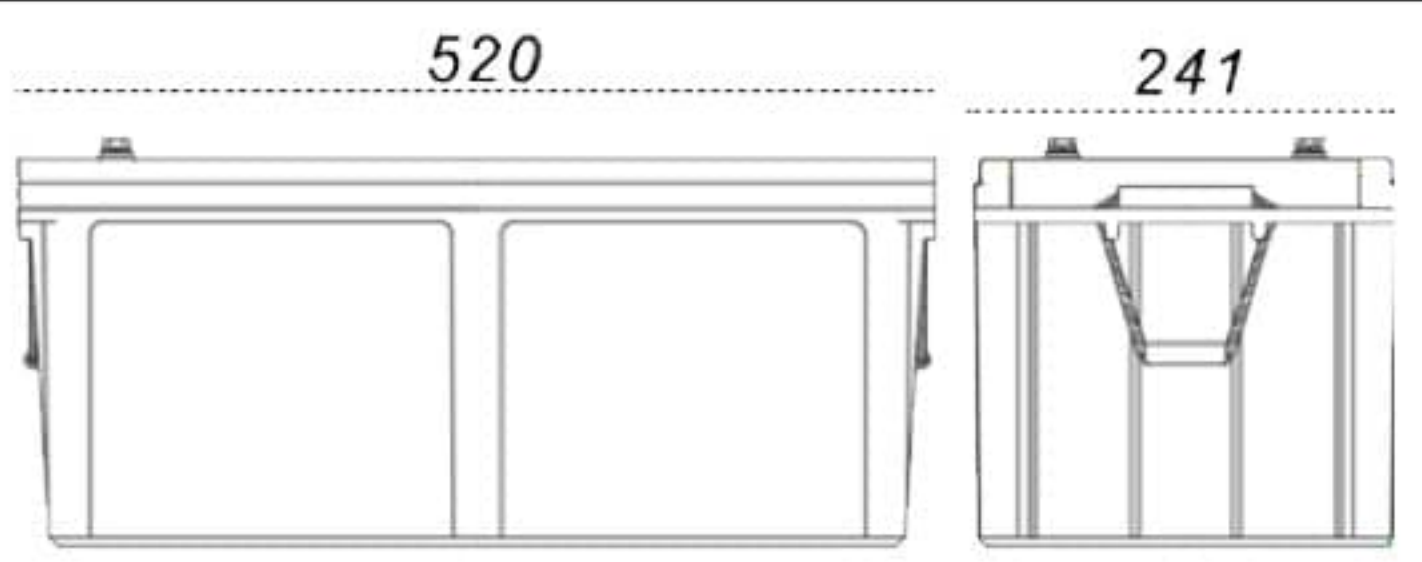

Rated Voltage (V):	12
Rated Capacity (Ah):	250
Dimension (mm):	520*272*225
Connection:	Optional
Weight (KG):	69.8

**BATTERY DISCHARGE CURVE AT 25°C**

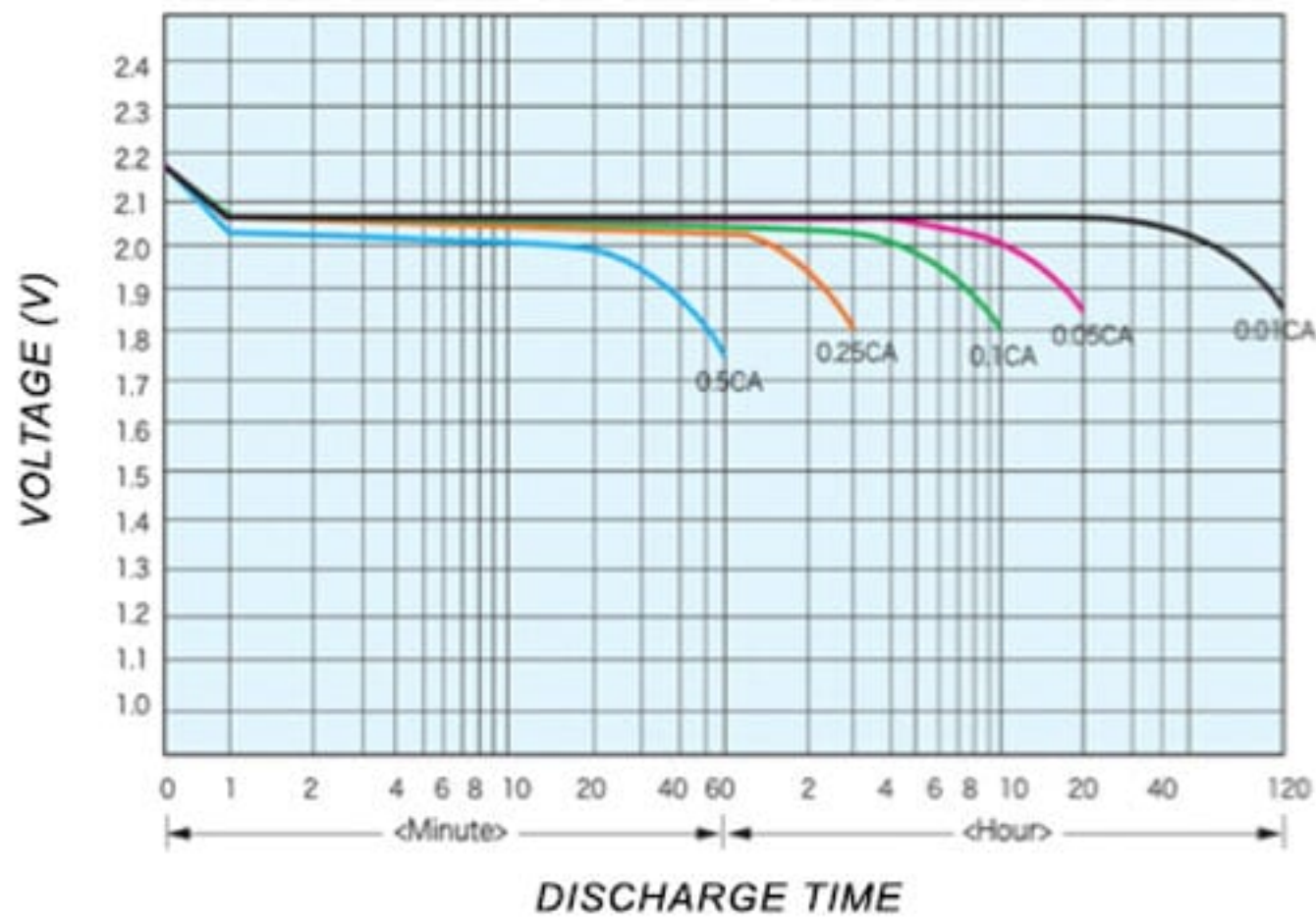

**BATTERY SELF-DISCHARGE DURING STORAGE AT 25°C**

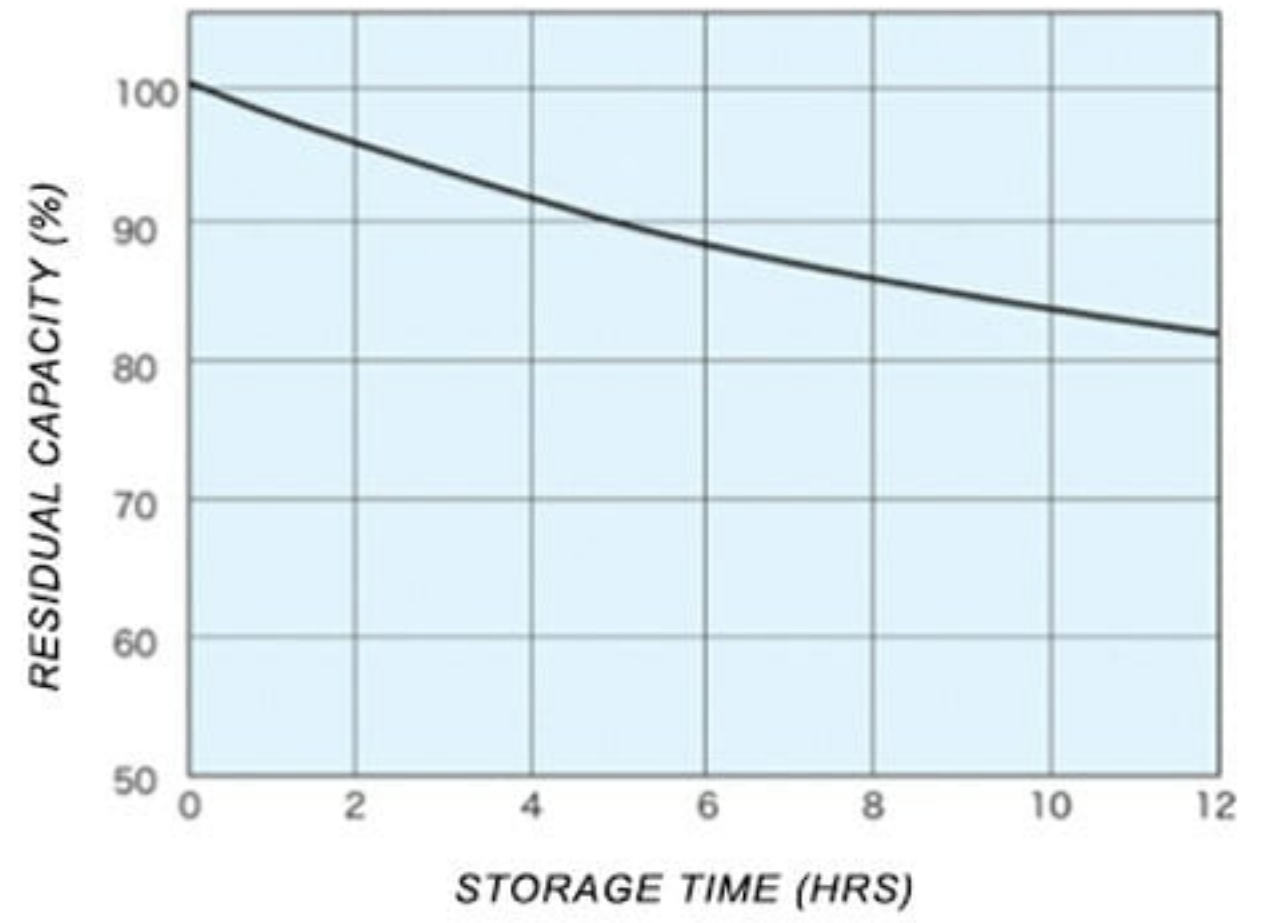

**BATTERY CHARGE VOLTAGE VS. TEMPERATURE**

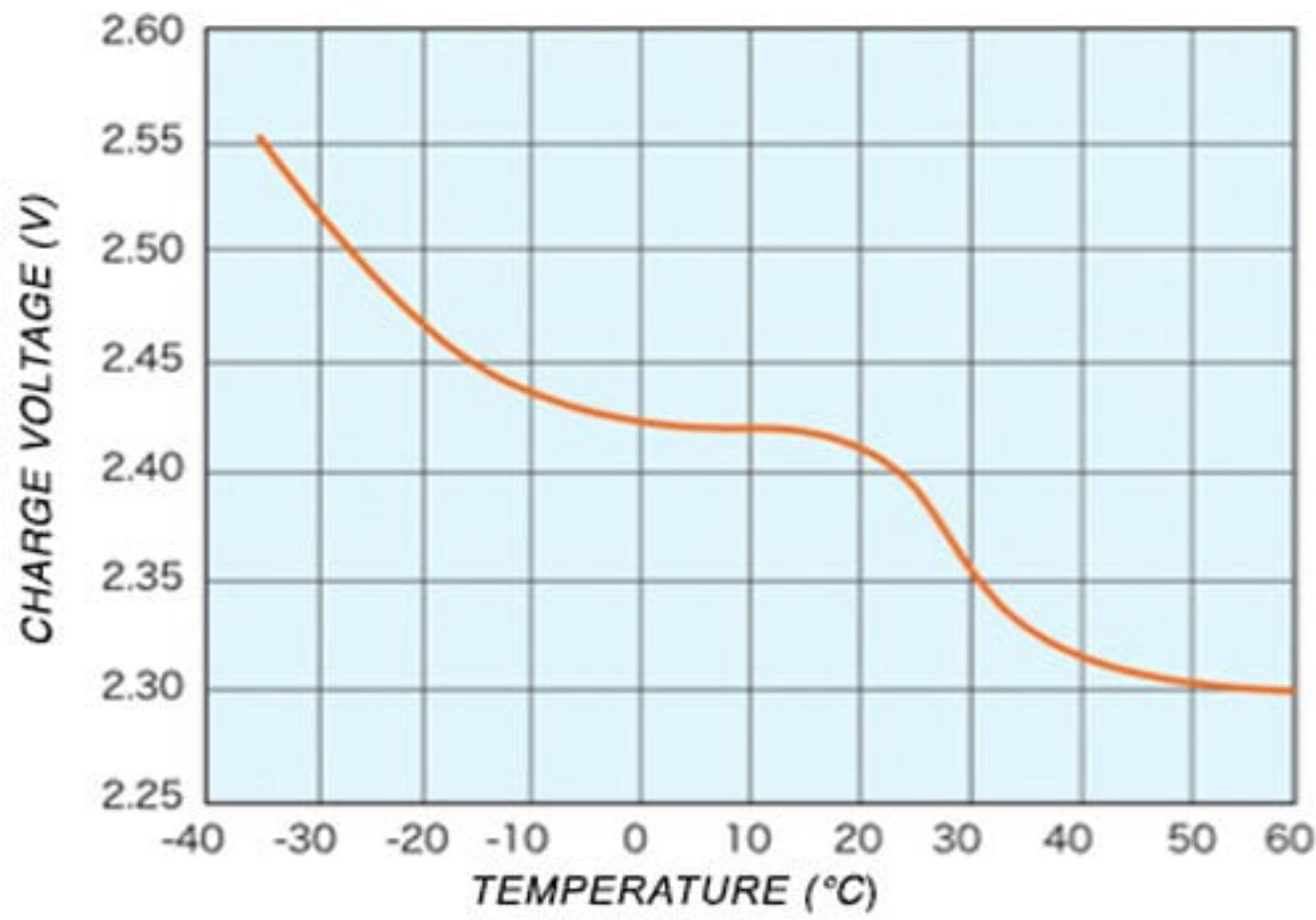

**BATTERY CAPACITY VS. TEMPERATURE ENVIRONMENT**

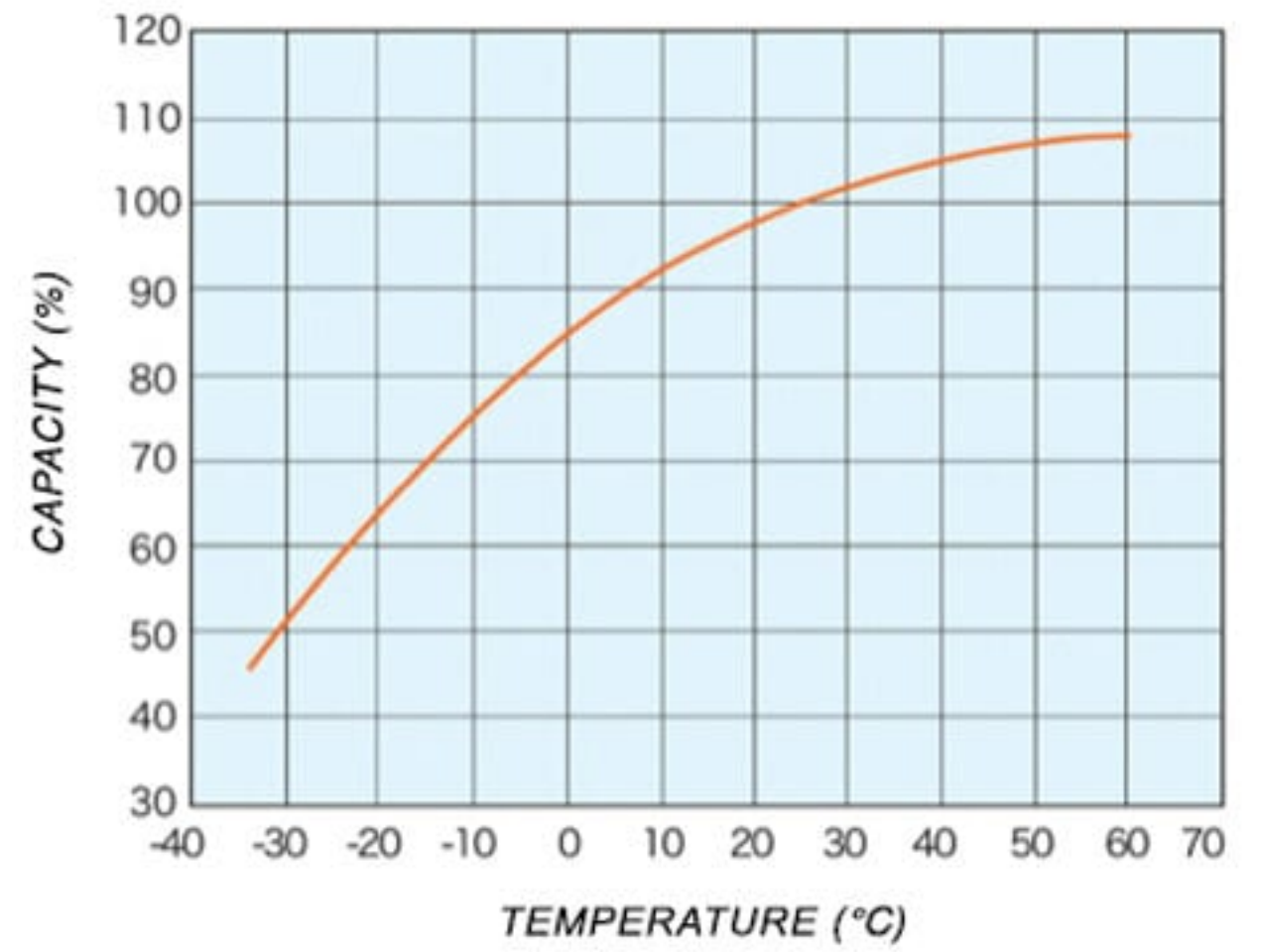

**BATTERY CHARGE CURVE AT 25°C**

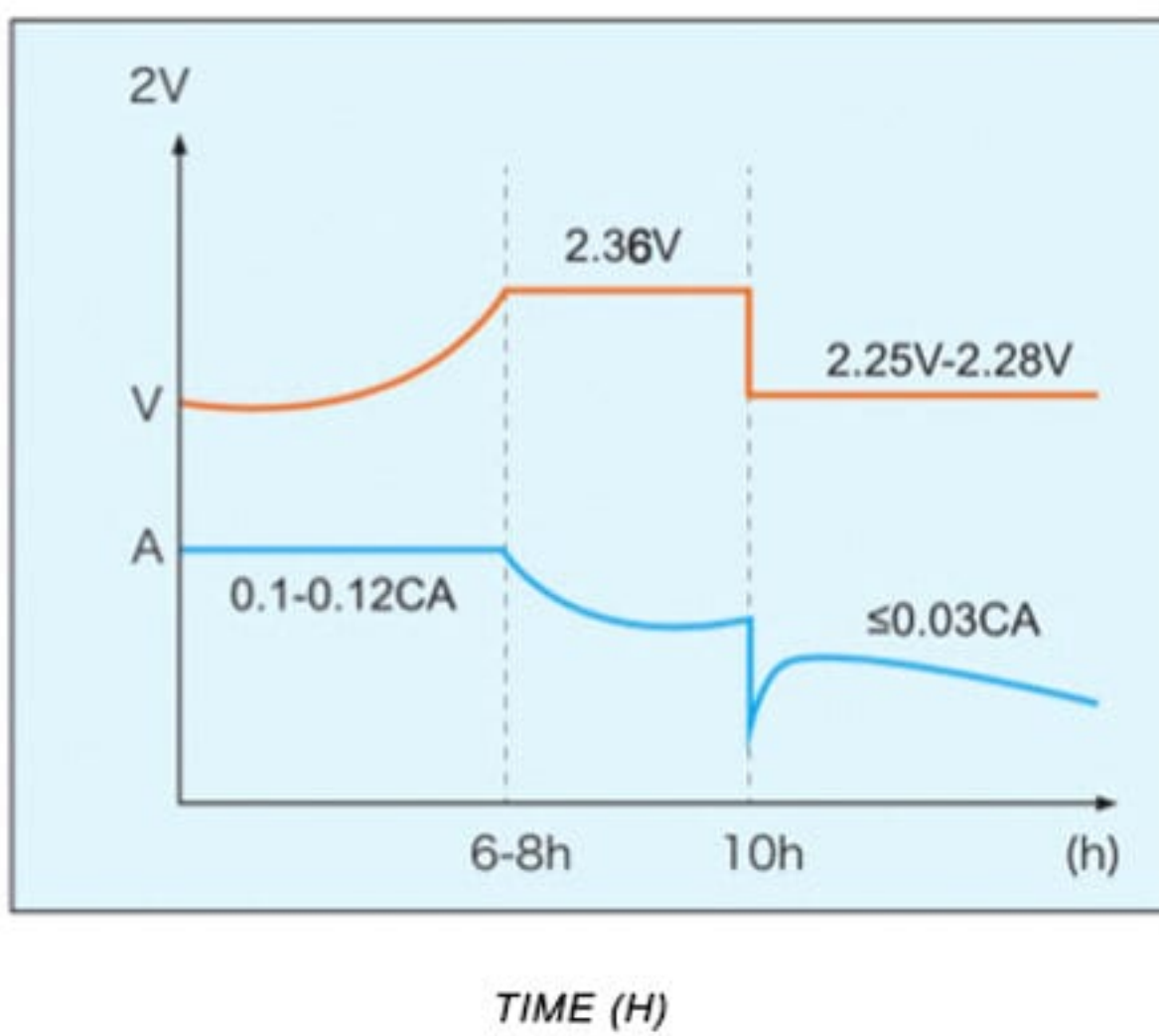

**BATTERY DISCHARGE DEPTH VS. CYCLE TIME RELATION AT 25°C**

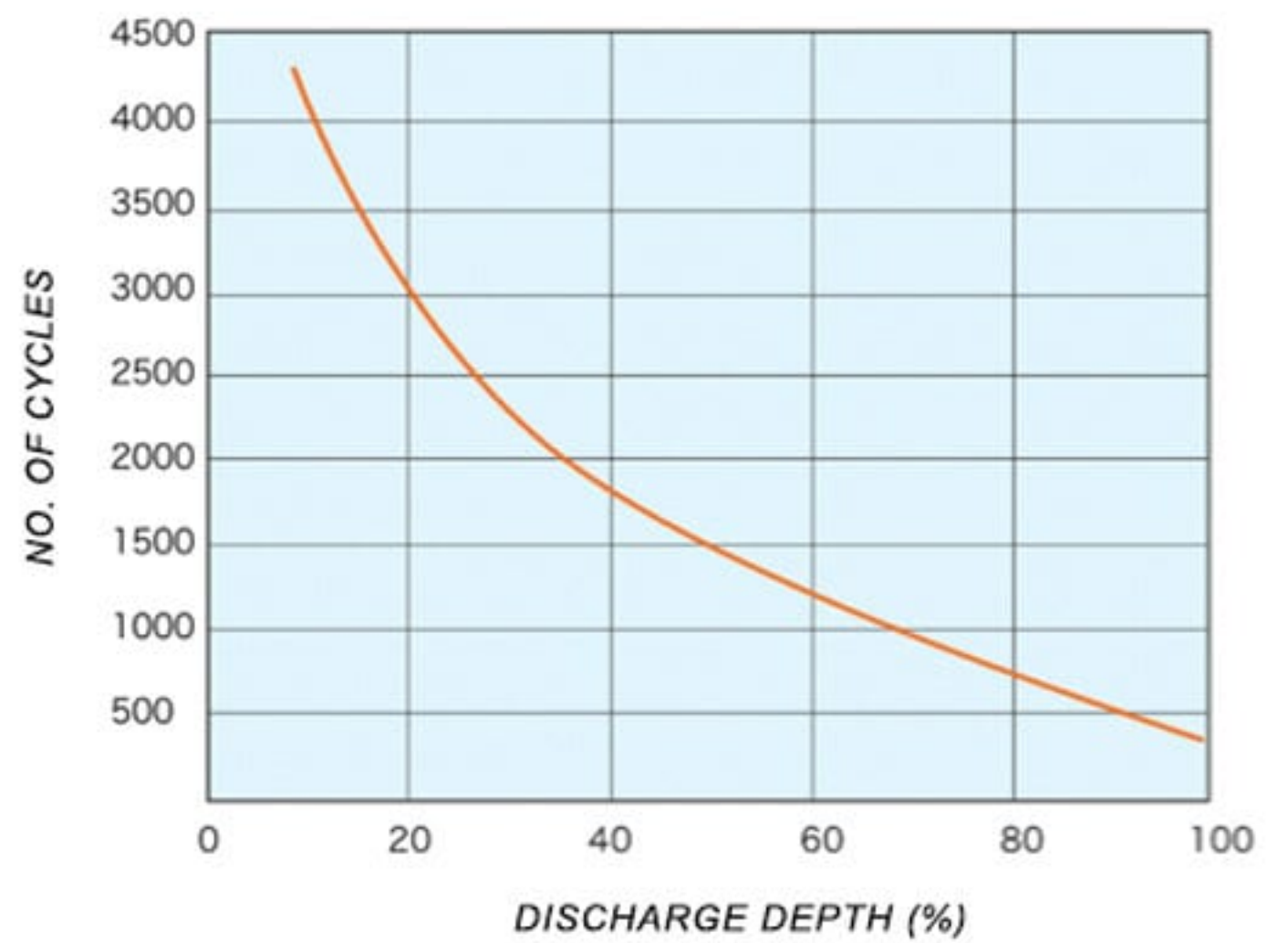

**FOR MORE INFORMATION, PLEASE CONTACT US:**

**Solar Panel Energy (Pty) Ltd**  
 inquiry@solarpanelenergy.co.za  
 www.solarpanelenergy.co.za